

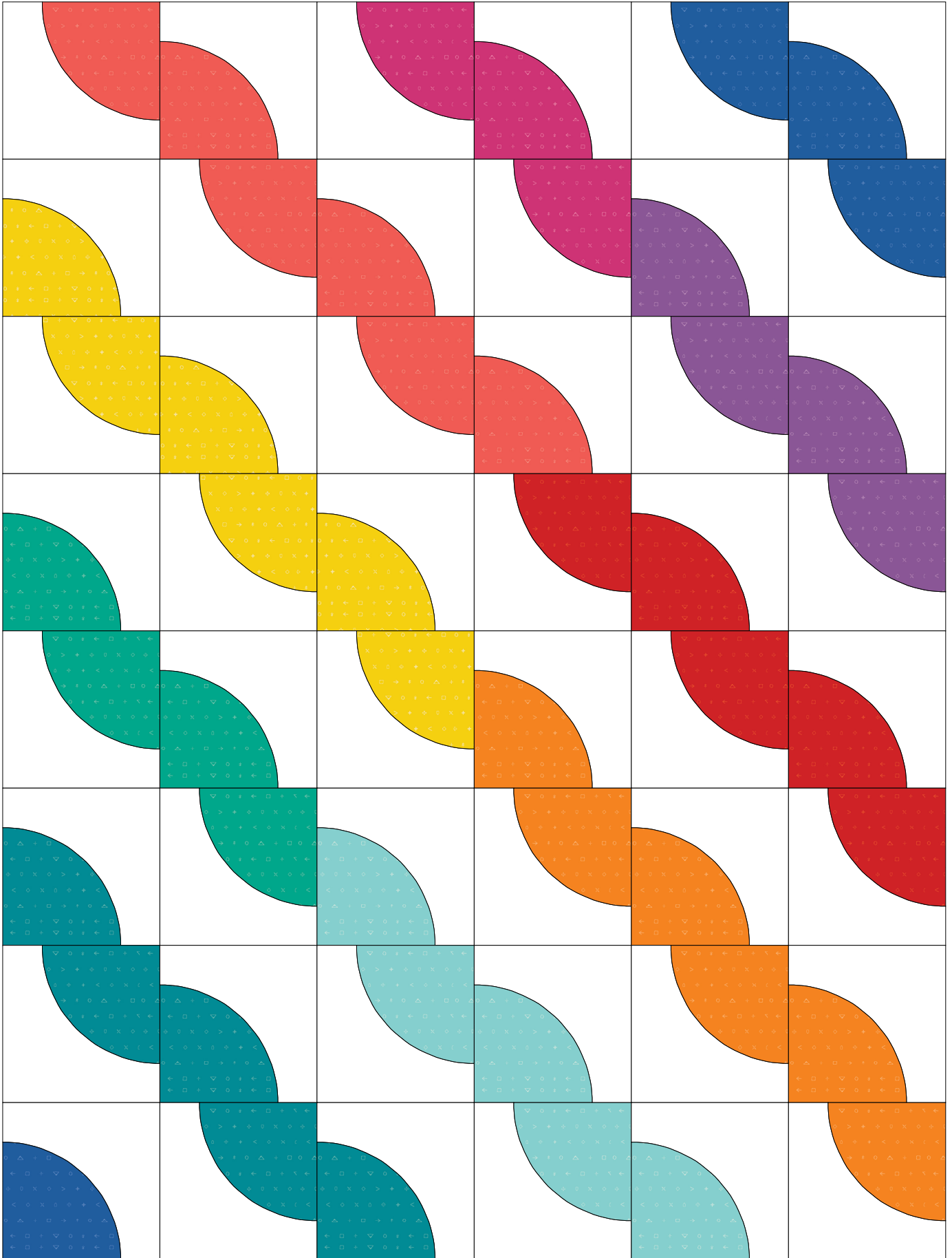









Rainbow Ripples

Overall Size: 36.00 by 48.00 inches





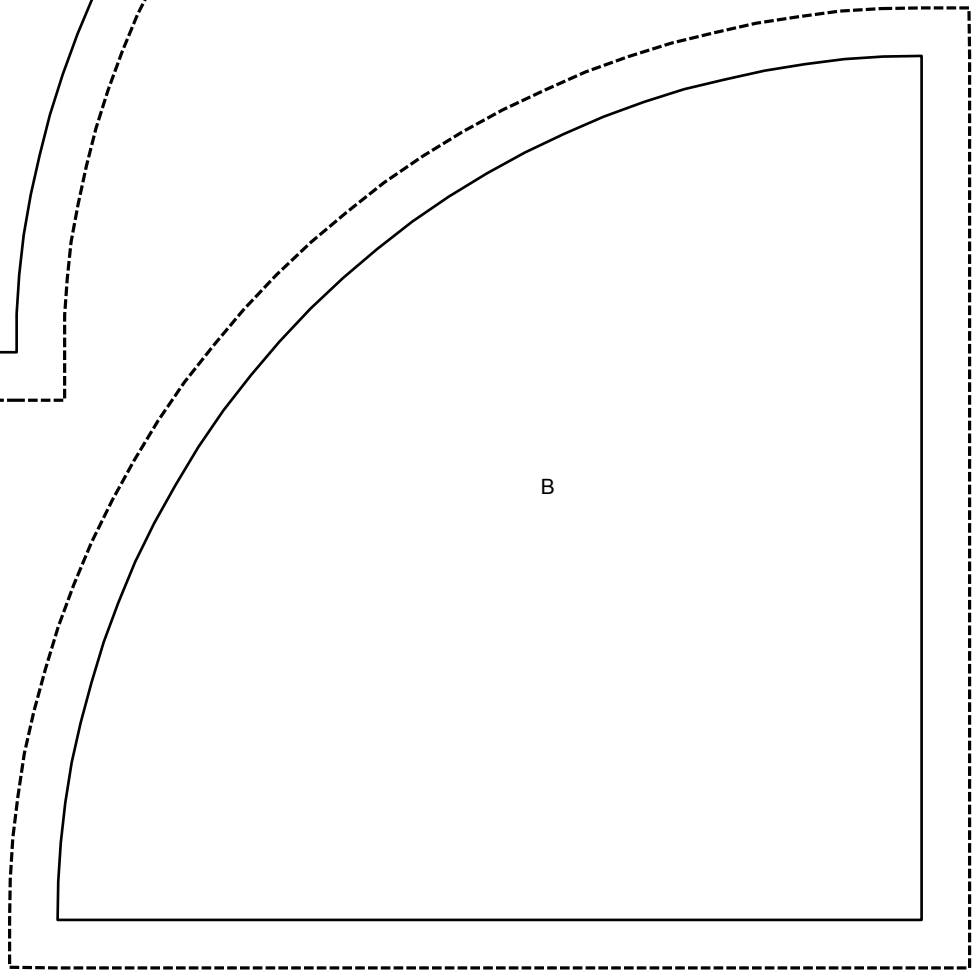
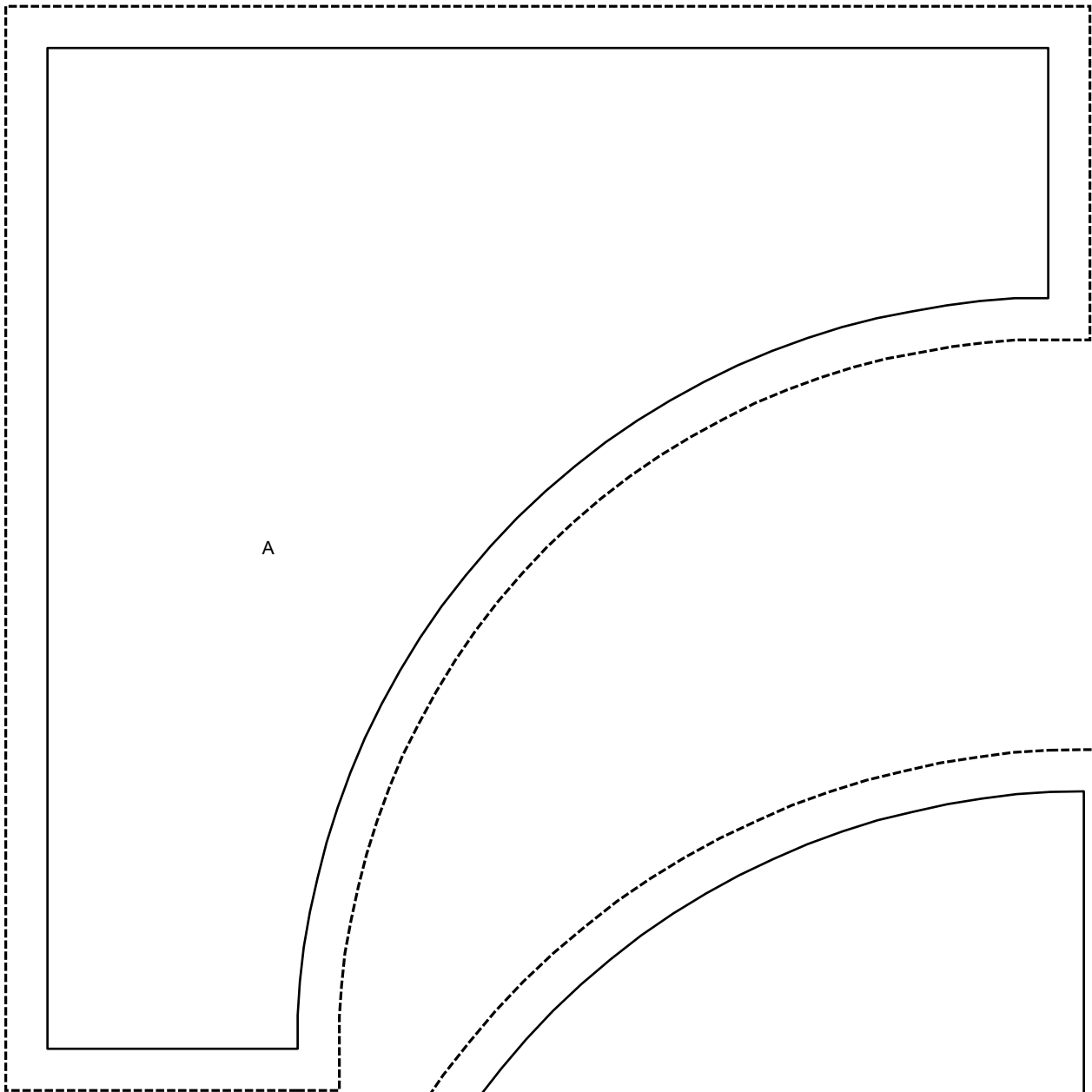





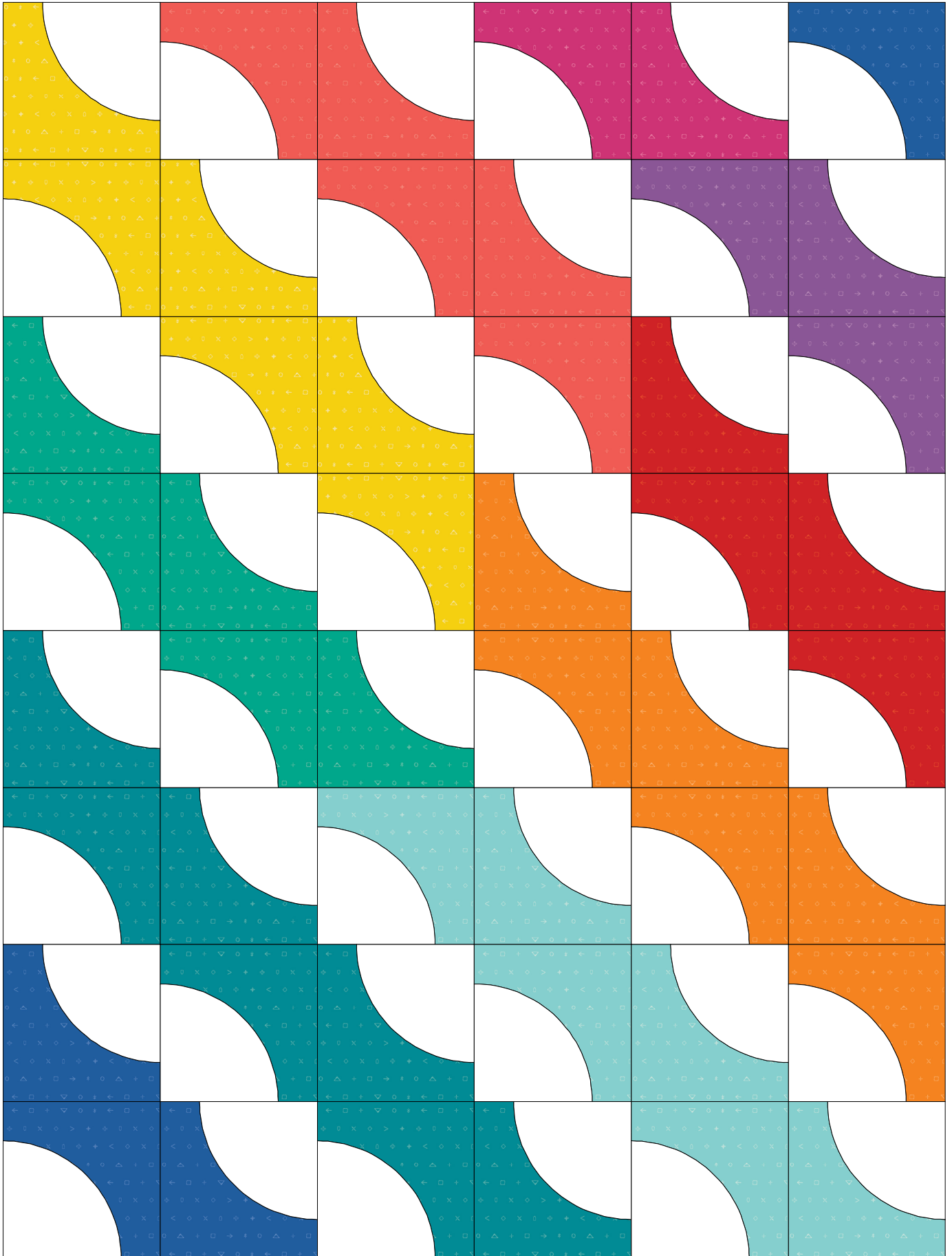

Fabric width 44-45 inches	Number of patches	Yardage estimate	Fabric name SKU
	48	1 + 1/2	Solid
	6	1/4	ICE-202-Coral-Emblem_500px
	3	1/4	ICE-204-Watermelon-Bar_500px
	4	1/4	ICE-206-Cobalt-Star_500px
	6	1/4	ICE-200-Golden-Token_500px
	4	1/4	ICE-205-Titan-Violet_500px
	4	1/4	ICE-208-Jade-Arrow_500px
	5	1/4	ICE-203-Apple-Pop_500px
	6	1/4	ICE-201-Coquelicot-Fire_500px
	5	1/4	ICE-207-Legend-Lake_500px
	5	1/4	ICE-209-Character-Sky_500px

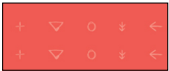

Reverse Ripples

Overall Size: 31.50 by 42.00 inches



Fabric width 44-45 inches	Number of patches	Yardage estimate	Fabric name SKU
	6	1/4	ICE-200-Golden-Token_500px
	48	3/4	Solid
	5	1/4	ICE-202-Coral-Emblem_500px
	2	1/4	ICE-204-Watermelon-Bar_500px
	4	1/4	ICE-206-Cobalt-Star_500px
	3	1/4	ICE-205-Titan-Violet_500px
	5	1/4	ICE-208-Jade-Arrow_500px
	4	1/4	ICE-203-Apple-Pop_500px
	6	1/4	ICE-201-Coquelicot-Fire_500px
	7	1/4	ICE-207-Legend-Lake_500px
	6	1/4	ICE-209-Character-Sky_500px

Yardage for 5.25" block

5.25" block to use up
leftovers from the
bigger 6.5" block

